

PJ-A3000

SERIES 302 – Profile Projectors

- The PJ-A3000 Series profile projectors comprises medium-size bench-top models that feature excellent versatility and easy operation.
- Easy-to-read digital XY counter is located near the projection screen to minimize eye movement.
- Digital readout protractor screen enables accurate angle measurement.
- Combination use with the optional 2D Data Processor QM-Data200 facilitates a variety of dimensional measurement methods.

MeasurLink ENABLED
Data Management Software by Mitutoyo

302-701-1E



Specifications

Model	PJ-A3010F-100	PJ-A3010F-200
Code No.	302-703-1E	302-701-1E
XY stage travel range	100 x 100 mm	200 x 100 mm
Measurement method	Linear encoder	
Resolution	0.001 mm or .0001" / 0.001 mm (.00005" / 0.001 mm: digital head)	
Focussing method	Manual	
Quick-release mechanism	X and Y axes	
XY stage size	250 x 250 mm	380 x 250 mm
Effective glass size	142 x 142 mm	266 x 170 mm
Swivel function	—	±3°
Maximum stage loading	10 kg	8 kg
Maximum workpiece height	91 mm	92.5 mm
Contour illumination	Light source	Halogen bulb (24V, 150W)
	Optical system	Telecentric
	Functions	2-step (high/low) brightness switch, heat-absorbing filter, cooling fan
Surface illumination	Light source	Halogen bulb (24V, 150W)
	Optical system	Vertical illumination with adjustable condenser lens
	Functions	Heat-absorbing filter, cooling fan
Mass	112 kg	140 kg

Technical Data

Projected image:	Inverted
Protractor screen	
Effective diameter:	315 mm (12.4")
Screen material:	Fine-ground glass
Screen rotation:	±360°, fine feed and clamp
Angle reading:	Digital counter (LED)
	Resolution: 1' or 0.01° (switchable)
	Range: ±370°
	ABS/INC mode switching, zero set
Reference lines:	Cross hairs
Projection lens:	10X (172-202)
	Optional: 20X, 50X, 100X
Magnification accuracy	
	Contour illumination: ±0.1% or better
	Surface illumination: ±0.15% or better
Power supply:	240VAC ±10%, 50/60Hz

Projection Capacity

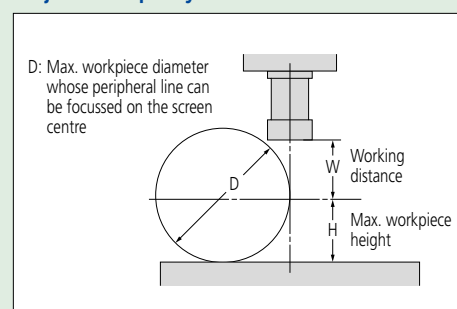

Unit: mm

	Magnification			
	10X	20X	50X	100X
View field	ø31.5	ø15.7	ø6.3	ø3.1
W	66 (20)	32.5 (2)	12.6	5
H	-100 model	91		
	-200 model	92.5		
D	-100 model	182	87 (61)	27
	-200 model	185	87 (61)	27

(): When using surface illumination.

Optional Accessories

Code No.	Description
172-116	Standard scale (50 mm)
172-117	Standard scale (2")
172-118	Reading scale (200 mm)
172-119	Reading scale (8")
172-160-2	Green filter
172-161	Reading scale (300 mm)
172-162	Reading scale (12")
172-202	10X projection lens set
172-203	20X projection lens set
172-204	50X projection lens
172-207	100X projection lens
172-229	Oblique illumination mirror for 10X lens
172-230	Oblique illumination mirror for 20X lens
332-151	OPTOEYE-200 image edge sensor*
383876	Vinyl cover
512305	Halogen bulb (24V, 150W)
999678D	Fixture mount adapter
12AAA807D	RS-232C cable

Fixture and stage accessories refer to page J-30.

QM-Data200 2D data processing unit refer to page J-28.

* For details refer to page J-29.

Technical Data

Program functions:	Part program creation, execution, editing
Statistical processing:	Number of data, maximum value, minimum value, mean value, standard deviation, range, histogram
Element memory:	Maximum of 1000 elements
Element recall:	Point, line, circle, distance, ellipse, rectangular hole, slotted hole, intersection and intersecting angle
Element key-in:	Point, line, circle
Display system:	Colour graphic TFT LCD
Measurement result file output:	RS-232C output (CSV format, MUX-10F format)
Display language:	Japanese/English/German/French/Italian/Spanish/Portuguese/Czech/Chinese (simplified/traditional), Korean
Data input:	RS-232C, XYZ-axis signal, footswitch
Data output:	RS-232C, printer
Power supply:	240VAC ±10%, 50/60Hz



264-156E Flexible-arm type.

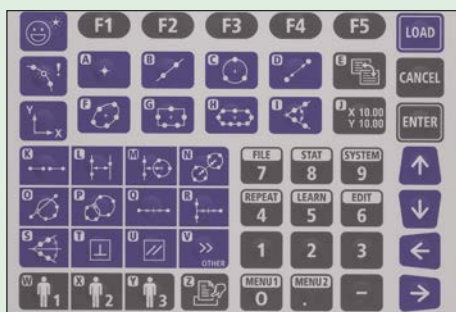

Intuitive panel design

The QM-Data200 employs Geometry Keys to accelerate the measurement process. The routine of probing geometric features and combinations is implemented from these dedicated keys on the front panel. Simply clicking a key and then capturing the feature coordinates means you can complete the measurement quickly and accurately. This improves operator productivity, reduces errors and saves operation time and cost.

Optional Accessories

SERIES 264 – QM-Data200 2D Data Processing Unit for Profile Projectors

- The QM-Data200 is a geometric readout/analysis unit for optical instruments such as profile projectors and measuring microscopes.
- This unit features powerful 2D coordinate measurement capabilities with easy-to-use key operation.
- The QM-Data200 improves operator productivity, minimizes errors and saves total measurement time and production cost.
- Informative graphic displays on the large LCD screen make for easy measurement operations.
- One-key operation for combined measurements that are often used (circle-circle distance, etc.).
- The AI measurement function (Automatic Identification of measuring item) eliminates switching between the measurement command keys.
- Equipped with a measurement procedure teaching function and measuring position navigation in Repeat mode.
- The user-menu function allows the user to store measurement commands or part programs to create custom menus.
- Tolerance zone measurement of data processing results and various statistical processing routines for each item are available.
- Measurement result output in spreadsheet (CSV) format.
- Two models are available for profile projectors: a stand mounted type with a tilt system and a flexible-arm type that attaches to the side of the instrument next to the screen.

MeasurLink ENABLED
Data Management Software by Mitutoyo



264-155E Stand mounted type

Specifications

Model No.	QM-Data200	
Code No.	264-155E	264-156E
Type	Stand mount	Flexible arm
Unit of measurement	mm	
Angle	Switchable between decimal degree and sexagesimal notation	
Resolution	0.1 μm	
Display unit	Colour graphic LCD (equipped with a backlight)	
External dimensions (W x H x D)	260 x 242 x 310 mm (including the stand section)	318 x 153 x 275 mm (when the arm is horizontal)
Mass	Approx. 2.9 kg	Approx. 2.8 kg

Graphic display

Measurement information and data are visualized on the back-lit LCD colour display with graphical interfaces. The geometric feature selected is displayed with the probing navigator. The measurements map and blink indication show the probing points and sequences. Simply probe points and click by following the blink indicator. Measurements can be easily completed even by a beginner. This improves operation accuracy and reduces errors and measurement time.

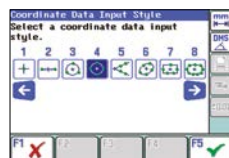

Clear function icons.

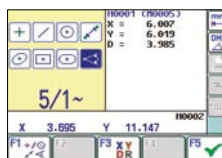

Coloured LCD display with backlight.



Guided measurements.

Optional Accessories

SERIES 332 – OPTOEYE-200 Image Edge Sensor for Profile Projectors

- The OPTOEYE-200 Image Edge Sensor eliminates the human error that can occur with visual alignment when using the cross hairs for edge location, thus ensuring speedy, accurate, and consistent measurements, regardless of the operator's skill level.
- Bright and dark buttons allow easy calibration.
- A thin fibre-optic cable for the detector connection allows easy set-up and use without obstructing the operator's vision.
- OPTOEYE is conveniently powered from the QM-Data200 via the connecting cable.



Optional Accessories

Code No.	Description
12AAE671	Sensor attachment A (for ø250 to ø350 mm screen of PJ-A3000 and PH-3515)
12AAE672	Sensor attachment B (for ø500 to ø600 mm screen of PV-5110)



Locating the edge of a hole.

Specifications

Code No.	332-151	
Image detection	Directivity	Non-directional
	Minimum diameter	ø2 mm on the screen
	Minimum width	1 mm on the screen
	Maximum capture speed	1000 mm/s
Illumination	Type	Surface/Contour
	Range	30 to 1500 Lux on the screen
Brightfield/darkfield difference	20 Lux	
Repeatability	1 µm in contour illumination mode	
Function	Creating, performing, and editing measuring procedures	

Scales for Profile Projectors

Standard Scales

Used for checking magnification accuracy in conjunction with a reading scale.



Metric		
Code No.	172-116	172-330
Graduation	0.1 mm	
Range	50 mm	80 mm
Accuracy (20°C)*	±(3+5L/1000) µm	

* L = measured length (mm).

Inch	
Code No.	172-117
Graduation	.01"
Range	2"
Accuracy (20°C)	±.00013"

Reading Scales

Specially designed for inspecting the magnified image of a standard scale on the projection screen.



Metric			
Code No.	172-118	172-161	172-329
Graduation	0.5 mm		
Range	200 mm	300 mm	600 mm
Accuracy (20°C)*	±(15+15L/1000) µm		

* L = measured length (mm).

Inch		
Code No.	172-119	172-162
Graduation	.02"	
Range	8"	12"
Accuracy (20°C)	±.00071"	

Workpiece Fixtures for Profile Projectors

Rotary Tables

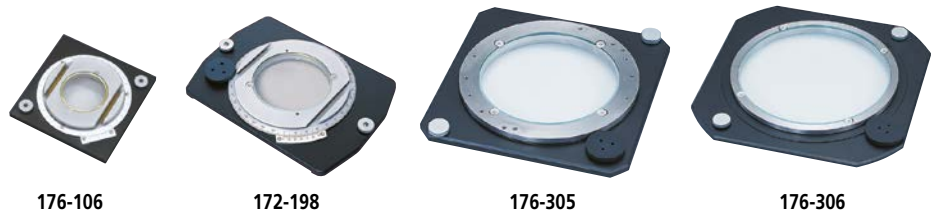

Code No.	176-106	172-198	176-305	176-306
Effective glass diameter	66 mm	96 mm	182 mm	238 mm
Angular resolution	6'	2'	—	
Fine feed	—		Available	
Mass	1.7 kg	2.4 kg	5.5 kg	6.5 kg

Holder with Clamp

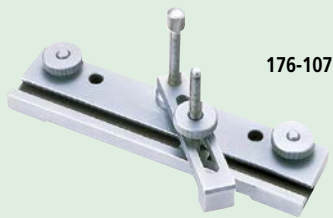

Code No.	176-107
Max. workpiece height	35 mm
Mass	0.42 kg

Vertical Holder



Code No.	172-132
Mass	1.3 kg

Centre Support and Centre Support Riser



Code No.	172-142	172-143
Description	Centre support	Centre support riser
Max. workpiece height	120 mm (240 mm*)	60 mm
Mass	3.3 kg	2.2 kg

* When using a centre support riser (172-143).

Swivel Centre Supports



Code No.	176-105	172-197
Max. workpiece diameter	70 mm (45 mm*)	80 mm (65 mm*)
Max. workpiece length	140 mm	
Swivel range	±10°	
Mass	2.4 kg	2.5 kg

* When swivelled 10°.

Rotary Vice

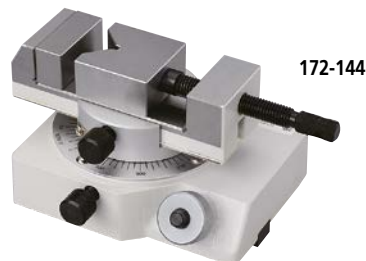

Code No.	172-144
Rotation range	360°
Maximum workpiece height	60 mm
Width of jaws	40 mm
Angle graduations	5°
Mass	2.8 kg

V-Block with Clamp



Code No.	172-234	172-378
Maximum workpiece diameter	50 mm	25 mm
Width of block	60 mm	41 mm
Mass	1.24 kg	0.8 kg